

3026319

11042016 - 02 - 05112019

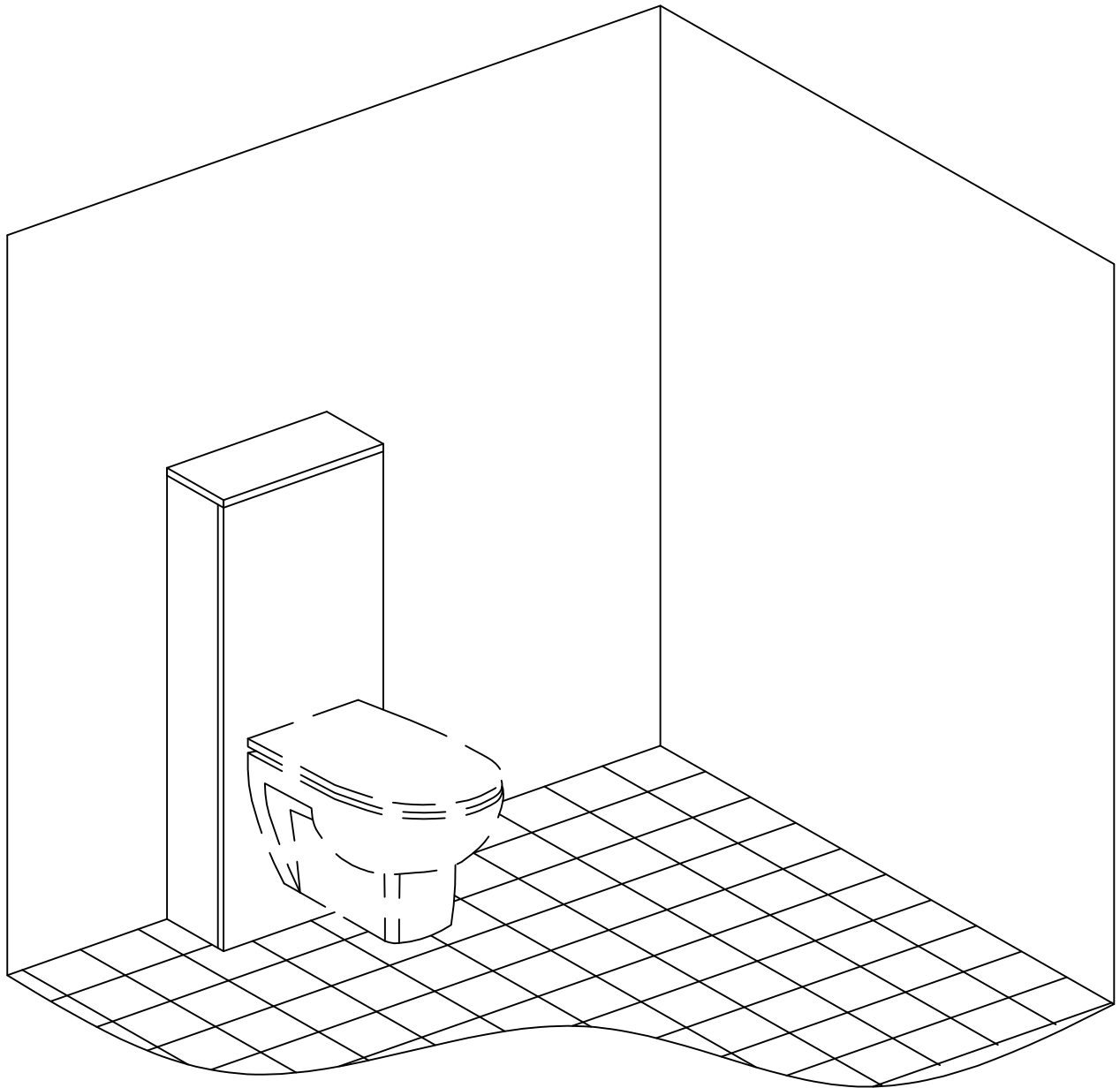



- (F) Cette notice est destinée à faciliter le montage du meuble, elle n'est pas contractuelle.
- (GB) Fitting instructions are intended to ease fitting. They are not subject to contract.
- (D) Unverbindliche Montageanleitung.
- (NL) Deze montagehandleiding is bedoeld om de montage te vereenvoudigen. Zij is niet bindend.
- (SP) Esta nota de instrucciones le ayudará a montar el mueble, no es contractual.
- (I) Le seguenti istruzioni sono destinate a facilitarvi il montaggio del mobile, e sono indicative.
- (P) Esta noticia é destinada a facilitar a montagem do móvel, não é contratual.
- (RUS) Настоящие инструкции помогут вам проще и быстрее собрать мебель. Производитель в любое время может внести изменения в изделие для улучшения качества и усовершенствования дизайна.



- (F) Le choix des types de vis et chevilles, ainsi que la méthode de perçage pour les fixations murales sont fonction de la nature et de la qualité du mur et, de ce fait, relèvent de la seule responsabilité du poseur.
- (GB) Since the type of wall determines the fittings necessary for each unit, bolts and screws have not been supplied but left to the responsibility of the installer.
- (D) Das Befestigungsmaterial (Schrauben und Dübel), muss je nach Beschaffenheit der Wand (Mauerwerk, Gipskarton etc.) ausgewählt werden. Die Verantwortung für die einwandfreie Installation, übernimmt der Fachmann.
- (NL) Omdat de manier van bevestigen bepaald wordt door het type muur, zijn schroeven en pluggen niet inbegrepen en vallen onder de verantwoordelijkheid van de installateur.
- (SP) La elección del tipo de los torillos y clavijos y el modo de perforar la pared dependen de la naturaleza y de la calidad del muro y por esto dependen de la responsabilidad de la persona quien instala.
- (I) La scelta dei tipi di viti e tasselli, oltre che il sistema di foratura per il fissaggio murale sono da scegliere in funzione della struttura e qualità del muro, e per questo. La responsabilità spetta a chi esegue la posa.
- (P) A escolha do tipos de parafusos e cavilhas assim que o metodo de furar para colocar as fixacoes murais depende da natureza e da qualidade do muro, e de facto, atribuem a unica responsabilidade ao instalator.
- (RUS) Поскольку каждая стена имеет свои особенности, крепеж для установки непоставляется. Специалист по сборке должен подобрать соответствующий тип креплений самостоятельно.



- (F) Tous les raccordements électriques doivent être réalisés selon les réglementations en vigueur par une personne qualifiée.
- (GB) All electrical connections must be made in accordance with the latest IEE regulations (BS EN) by a qualified person.
- (D) Alle elektrischen Anschlüsse, müssen gemäß den VDE-Vorschriften, von einem Fachmann installiert werden.
- (NL) Alle elektrische aansluiten dienen, conform de geldende normen, te worden geïnstalleerd door een erkend installateur
- (SP) Todas las conexiones eléctricas deberán ser realizadas por personal cualificado y siguiendo las regulaciones marcadas por el IEE (Instituto de Ingenieros Eléctricos)
- (I) Elettriche devono essere eseguite da personale qualificato e in conformità alle più recenti norme IEE (Institution of Electrical Engineers)
- (P) Todos os racordamentos eléctricos devem ser realizados segundo as reglementações em vigor por uma pessoa qualificada
- (RUS) Все электрический соединения должны устанавливаться квалифицированным персоналом и соответствовать последним стандартам IEE (Институт Инженерной, Великобритания)

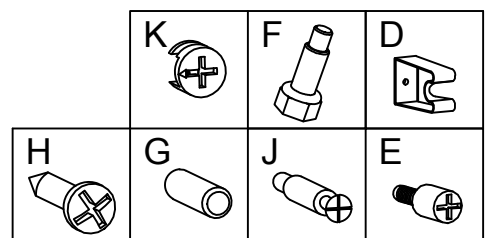
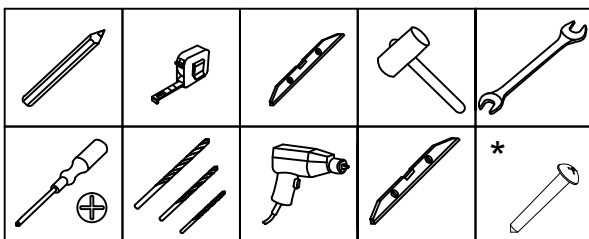
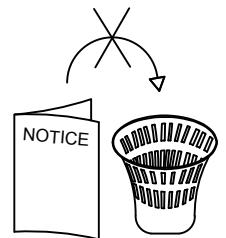
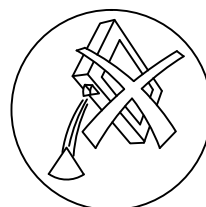
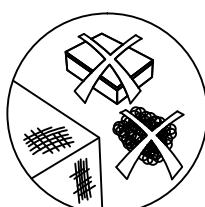
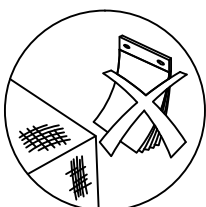
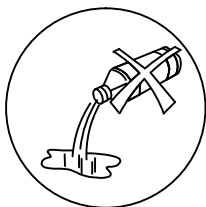
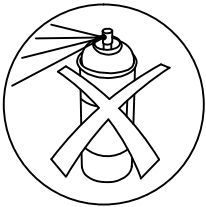

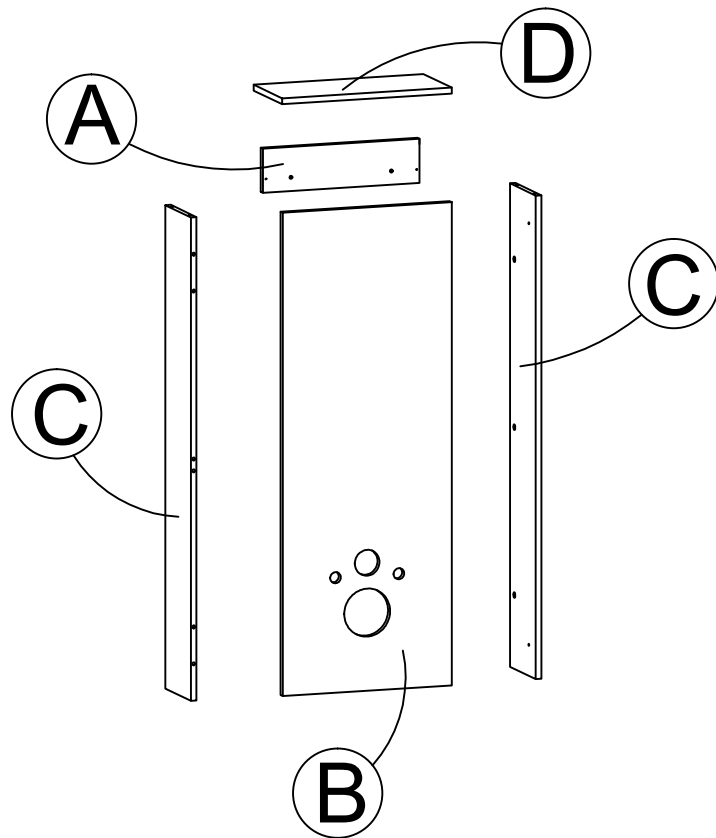

01

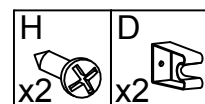
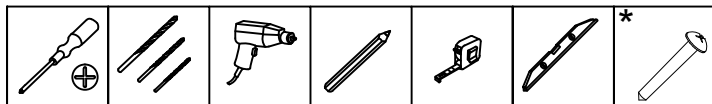
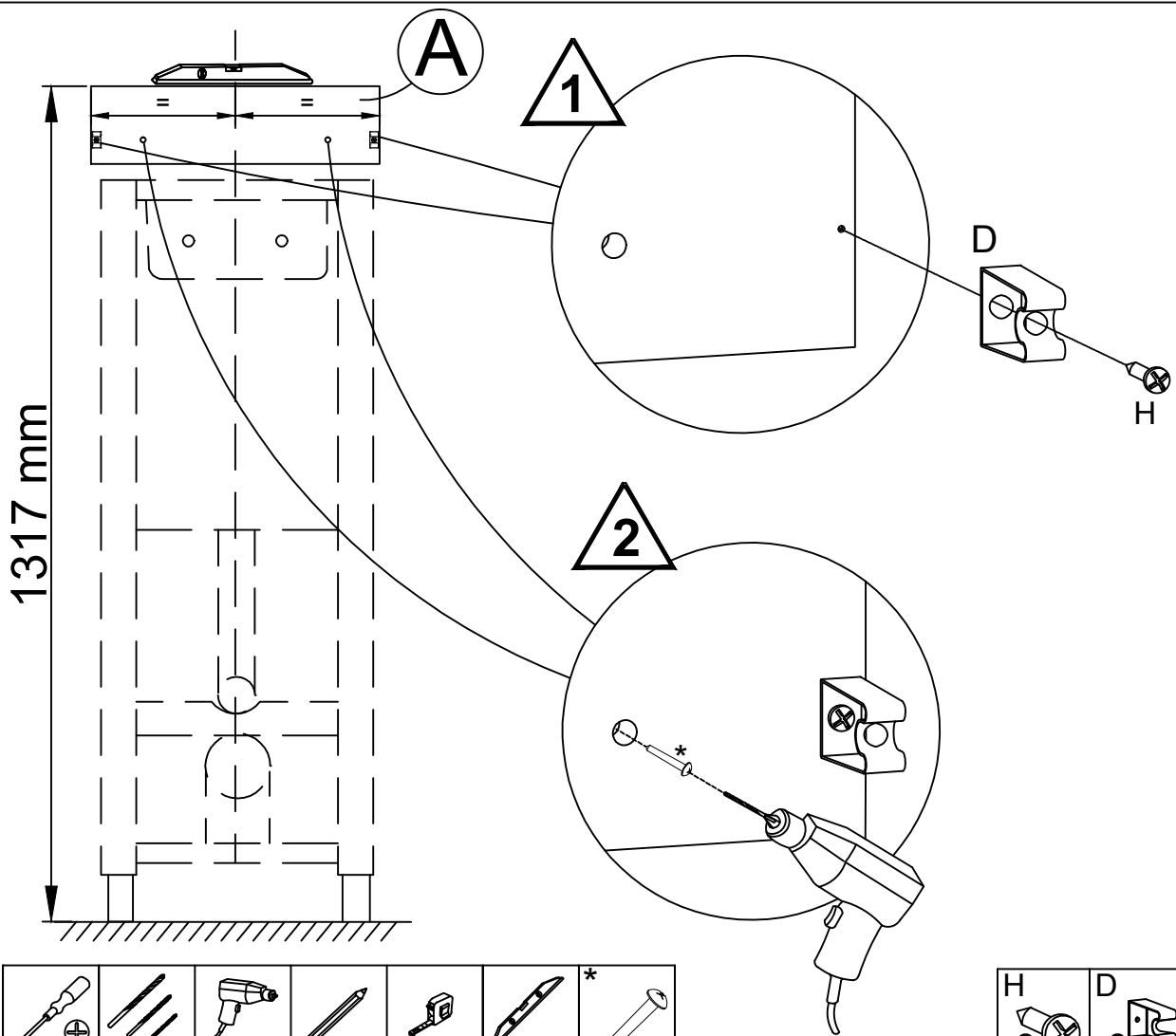

02

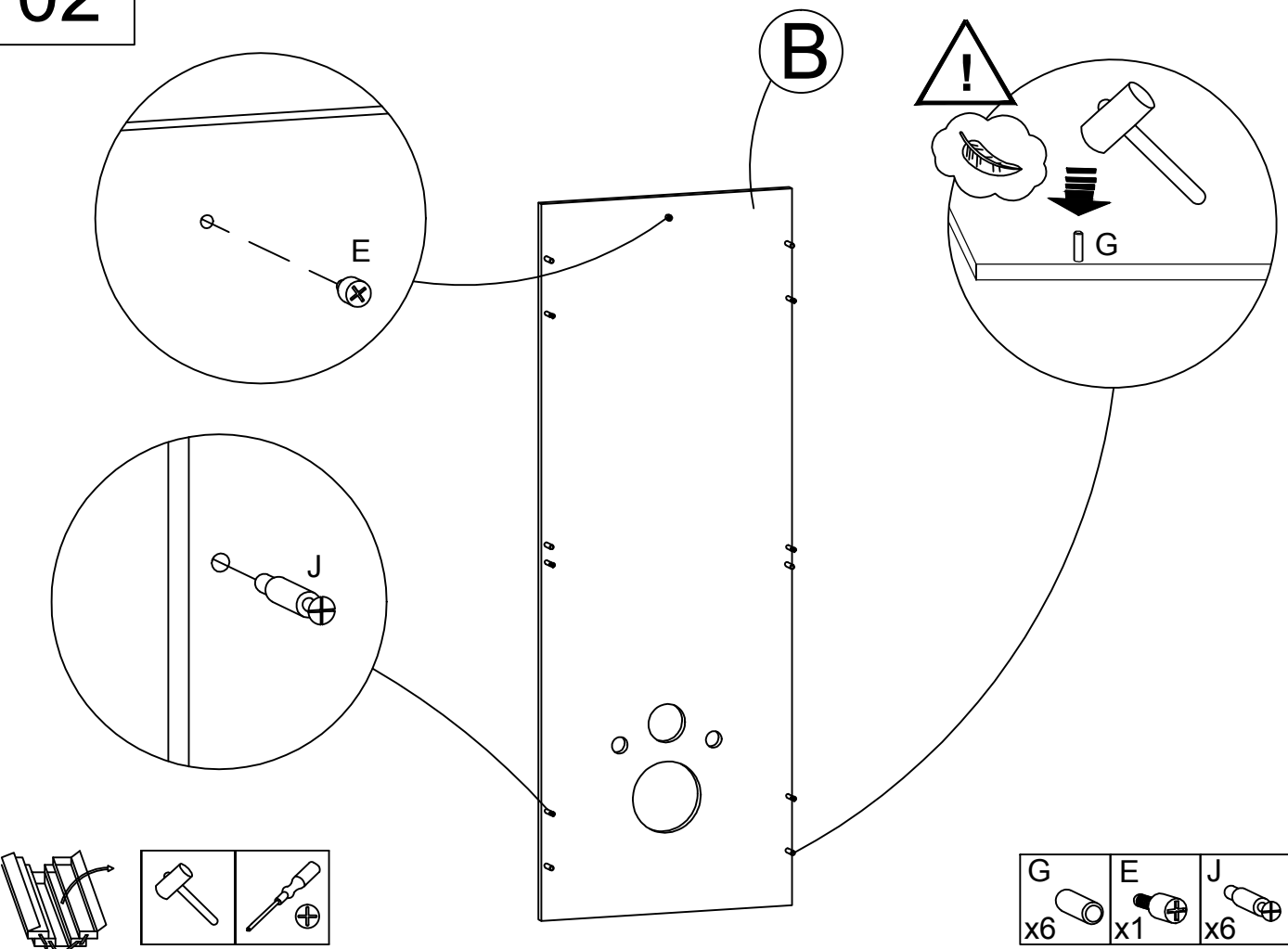

03

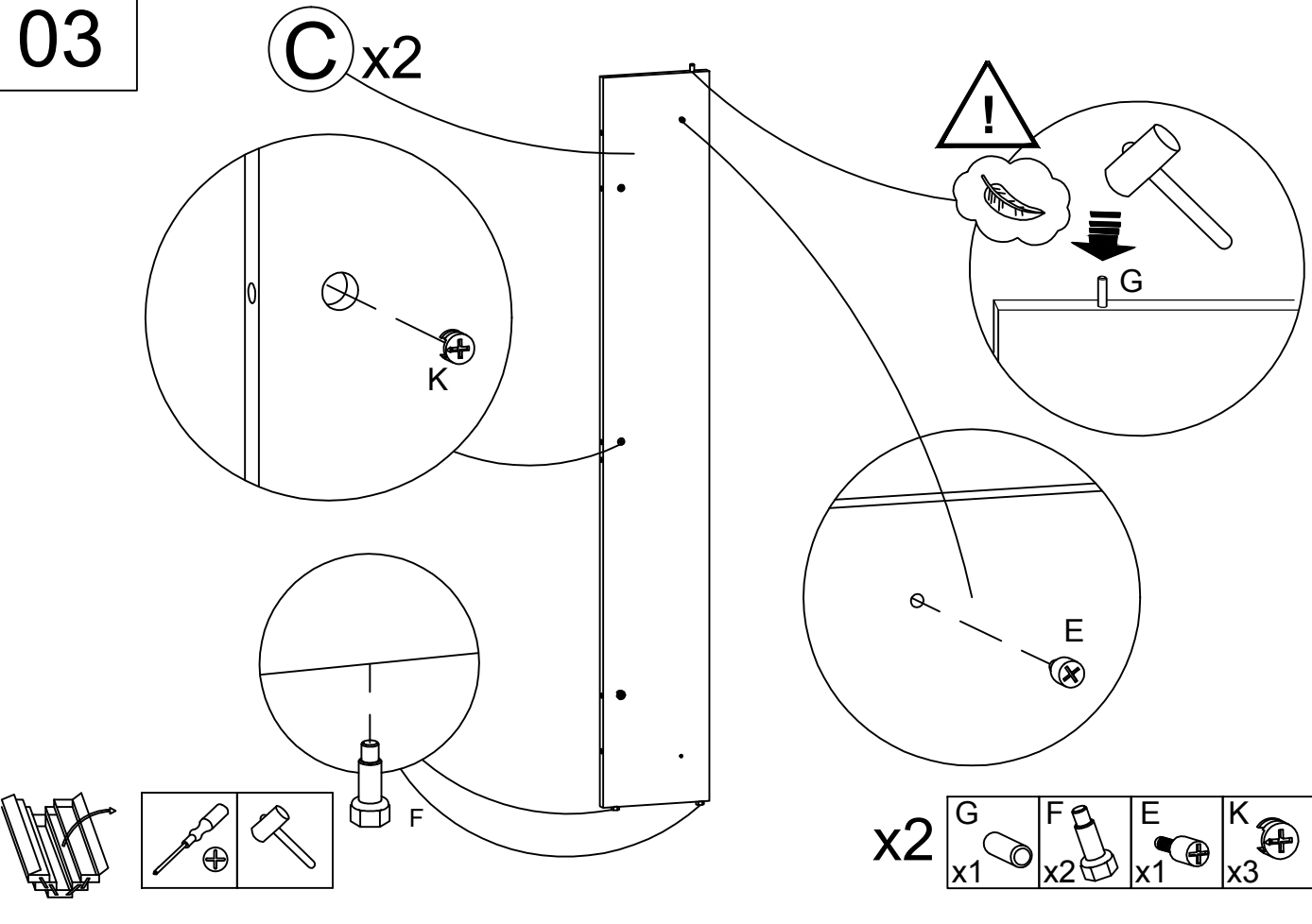

04

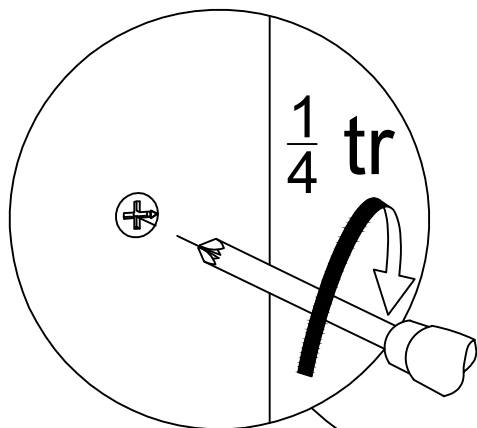

C

B

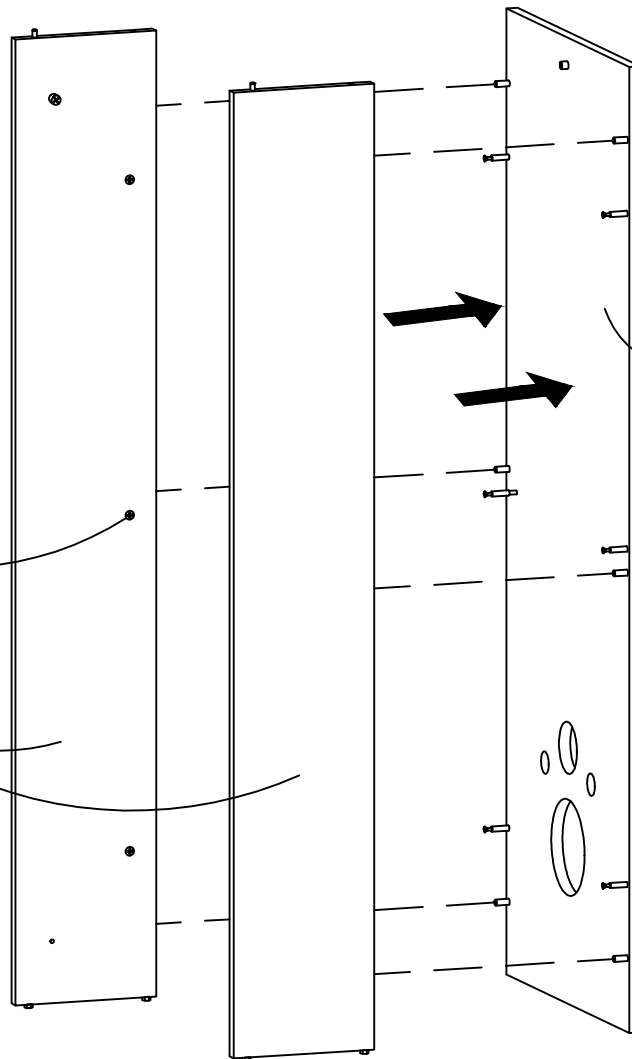

05

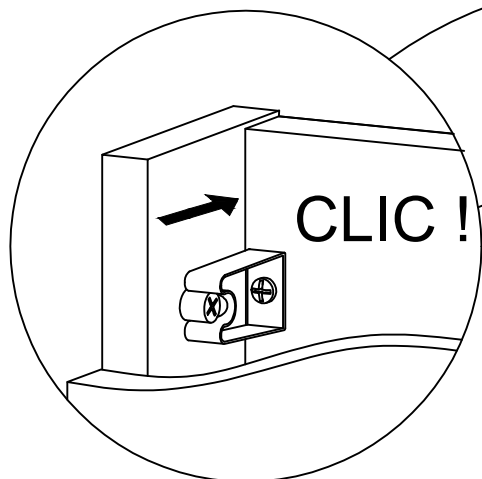

1

2

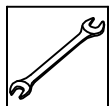
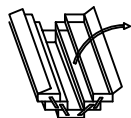
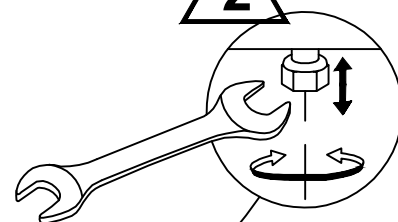
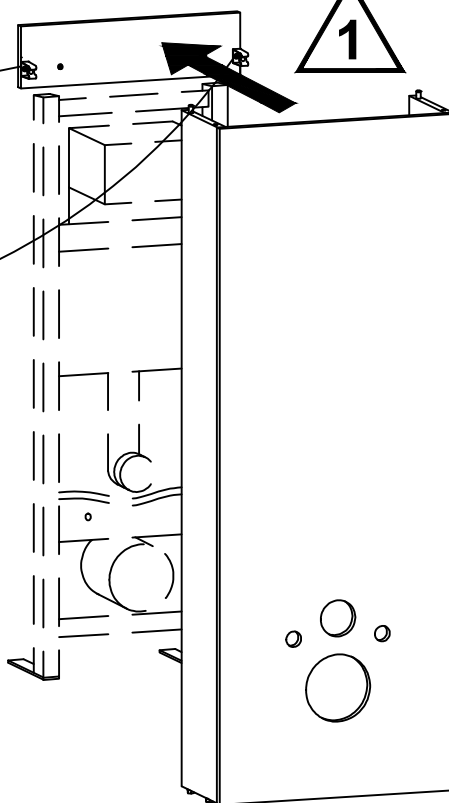

06

